

USER MANUAL

ENG

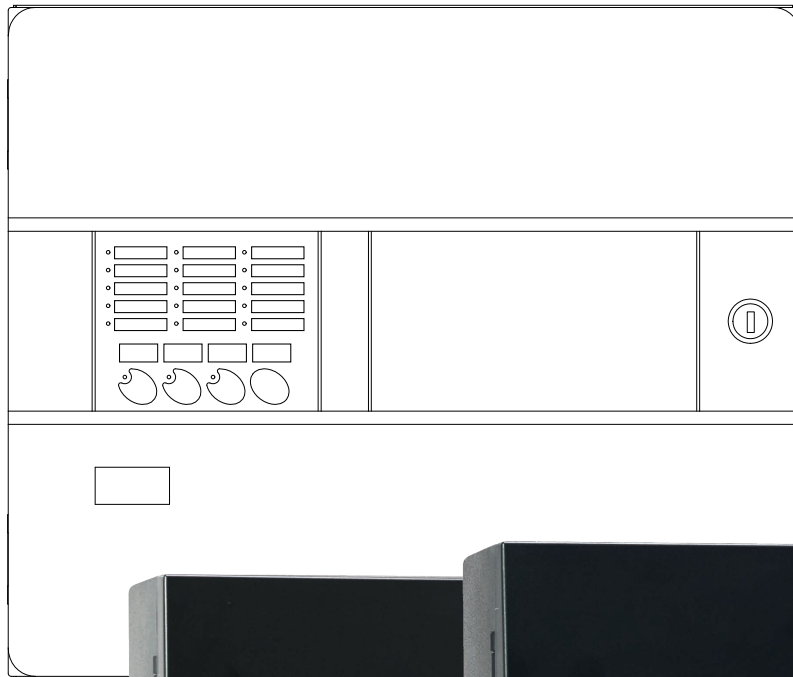



CONTENTS

1. INTRODUCTION	6	6.4. PRINTER	20
1.1. ABOUT THIS MANUAL	6	6.4.1. Printer	20
1.2. EUROPEAN STANDARDS	6	6.4.2. Configuration	20
1.3. EXPLICIT DEFINITIONS	8	6.5. PANEL TEST	21
1.3.1. Notes on the use of this control panel	8	7. MAINTENANCE	22
1.3.2. Installation notes	8	7.1. LOG	22
1.3.3. Disclaimer	8	7.2. PERIODIC TESTS	22
1.4. CONTROL PANEL FEATURES	8	7.3. CLEANING	22
1.5. ARCHITECTURE	9	7.4. LOG	22
2. MAIN PANEL	10	8. EVENT SCREEN	24
2.1. GENERAL LEDS	10	9. TROUBLESHOOTING	26
2.2. GENERAL CONTROLS	11	9.1. FAULTS SHOWN ON THE PRIMARY CONTROLS	26
3. USER LEVEL	12	9.2. FAULTS SHOWN ON THE EVENT SCREEN	27
3.1. STANDBY SCREEN	12	10. TECHNICAL SPECIFICATIONS	30
3.2. USER ACCESS	12		
3.3. USER SCREEN	13		
4. DISABLEMENT MENU	14		
5. LOG MENU	16		
6. SETTINGS MENU	18		
6.1. GENERAL	18		
6.1.1. Miscellaneous	18		
6.1.2. Date selection	18		
6.2. VERSIONS	19		
6.3. CONNECTIVITY	19		

Revision control

Revision	Comment	Date
a	First edition	29/11/2019
b	Typographical correction and regulatory references	05/12/2019
c	Specification of correction, typographical errors and contents	16/12/2019
d	Lay out revision and corrections	16/06/2020

DISCLAIMER

The manufacturer or distributors of this range of fire alarm panels cannot accept any responsibility for any misinterpretation of an instruction or guidance note or for full system compliance.

The manufacturer's policy is of continuous improvement and we reserve the right to make changes to the product specifications at our discretion and without prior notice.

Incorrect assembly, improper installation, poor configuration of the unit or the state of the detection wiring are not the responsibility of the control panel manufacturer.

1. INTRODUCTION

1.1. ABOUT THIS MANUAL

The purpose of this manual is to provide the user with all of the descriptions regarding procedures and technical details necessary to carry out the assembly, connection and start-up of CAD-250 fire alarm control panels.

The accuracy of the contents of this manual is the most important aspect and on which all efforts have been focused; nevertheless, the manufacturer reserves the right to change the information without prior notice.

READ ALL INSTRUCTIONS carefully and fully before starting to install the control panel. This manual is of no use if you ignore any of the points described in it.

 If you have any queries regarding the assembly, installation or configuration of the control panel, please contact your distributor before continuing to install the equipment.

STORE THIS MANUAL in a place that is easy to access as it contains important instructions regarding installation and use. You may need to consult it until you familiarise yourself with the control panel.

MAKE SURE you have the necessary know-how to operate this control panel.

As required, the procedures are divided into one or more diagrams, depending on the complexity of the task.

 This guide does not describe the advanced features related to the configuration or operation of the control panel, as they are included in other manuals.

For more information, see:

- Installation Guide for the CAD-250 Control Panel
- Advanced configuration guide for the CAD-250 Control Panel

1.2. EUROPEAN STANDARDS



This panel has the distinctive CE mark to indicate that it meets the requirements of the following directives of the European Community.

Directive	Standard	Description
2014/30/EU		Electromagnetic Compatibility Directive
2014/35/EU		Low Voltage Directive
305/2011/EU		Construction Products Directive
	EN54-2	Fire detection and fire alarm systems.
	EN54-4	Power supply equipment

In addition to these directives, the manufacturing of this control panel meets the following European directives for manufacturing and waste management:



· 2011/65/EU (RoHS 2), European standard on the restriction of the use of certain harmful substances (lead, mercury, cadmium, hexavalent chromium, polybrominated biphenyls, polybrominated diphenyl ethers) in small and large household appliances, computer and telecommunications equipment, consumer electronic devices, lighting fixtures, electrical and electronic tools, toys, leisure and sports equipment, medical devices, control and surveillance instruments, including industrial control instruments, vending machines and other equipment not included in the previous categories.



· 2012/19/EU (WEEE), European standard on the recycling of non-disposable products, such as unclassified municipal waste within the area of the European Union. When purchasing an equivalent new unit, return this product to your local supplier or dispose of it at the collection points designated for this purpose in order to facilitate its appropriate recycling.





1.3. EXPLICIT DEFINITIONS

The procedures described in this manual include warnings and cautions to advise the user to adopt methodical and safe working practices during installation, start-up and configuration.

Please follow the warnings in this manual, as misuse or improper installation may result in incorrect assembly or even death.

These warnings alert you to serious fire and electrocution risks (high voltage areas, i.e. voltages that exceed the safety level), the risk of damage to elements of the control panel that are sensitive to static current or short circuits if the procedures or simple tips for facilitating the assembly, connection or installation processes are not followed.

The definitions are classified according to the following levels:

WORD	DEFINITION
 WARNING!	Risk of personal injury, fire or electrocution.
	Risk for the product and system
	There is no risk and no observations or comments to facilitate the action

1.3.1. Notes on the use of this control panel

KNOWLEDGE: Make sure you have the necessary knowledge and authorisation to operate this control panel.

⚠ WARNING! The improper or negligent use of the **USER** access level may cause a malfunction of the facility that can cause the loss of human lives.

1.3.2. Installation notes

Make sure an authorised installer has checked and certified your facility.

1.3.3. Disclaimer

The CAD-250 control panel is a fire prevention control panel that was created to comply with the most demanding operating conditions, whilst also being able to adapt to any facility thanks to the versatility provided by its modularity.

This control panel is certified according to the requirements of the European standard EN54 part 2 and EN54 part 4.

Remember that incorrect assembly, improper installation or poor configuration of the unit are not the responsibility of the control panel manufacturer.

Nor is the installation or the state of the detection wiring the responsibility of the control panel manufacturer.

1.4. CONTROL PANEL FEATURES

The **CAD-250** is an addressable control panel with advanced configuration and functional features, designed to work with **DETNOV** addressable sensors, modules and addressable butts. Its modular design provides the user with an extremely powerful and completely flexible system.





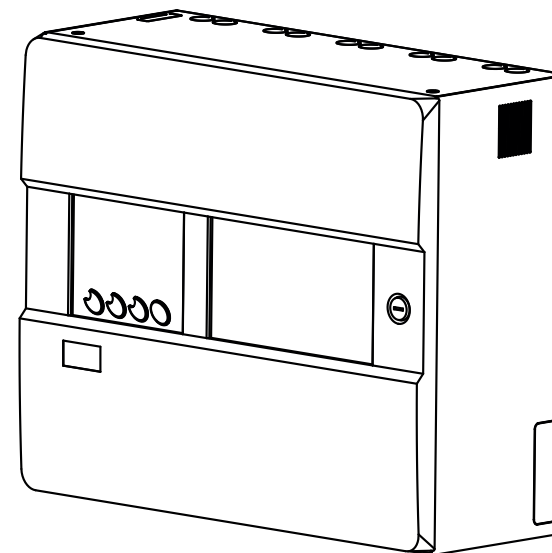



Basic configuration (single panel):

10" TFT COLOUR SCREEN (1024 x 600 pixels). The colour touchscreen allows the user to interact easily with the control panel.



CAD-250 in simple configuration

USER-FRIENDLY MULTILINGUAL INTERFACE. The graphical interface was designed for intuitive and user-friendly browsing and allows important information to be identified quickly in each case, such as alarms or events.

-  **2** sounder outputs.
-  **1** alarm output.
-  **1** fault output.
-  **8** loops and **2000** devices (250 per loop).
-  **1** Ethernet connection.
-  **1** Class A USB 1 ports for configuration with a pen drive and 1 Class B for configuration from SC250 software.
-  **64** network nodes.
-  **1 GHZ PROCESSOR**, high-speed microprocessor core.
-  **512 MB RAM**. It allows all information to be processed quickly.
- 8 GB FLASH** of internal static memory stores the software, image databases, etc.
- 1,000,000** events in the history log.

1.5. ARCHITECTURE

The modular design of the CAD-250 control panel allows up to 3 modular components to be combined in a single structure of up to 4 sections or cabinets.

This feature provides CAD-250 control panels with extraordinary versatility and power. As such, nodes or single control panels can be generated with a capacity of:

32 loops

8000 devices

2000 programmable zones

250 areas

1000 groups

250 virtual controls or relays

2500 special modes

Item	Ref.	Description
A	CAD-250	Main cabinet with interface Expands up to + 8 loops The ref. does not include the loops
B	CAD-250-BLED	Cabinet with 250 dual LEDs for zones Expands up to + 8 loops The ref. does not include the loops
C	CAD-250B	Blind cabinet to expand up to + 8 loops The ref. does not include the loops

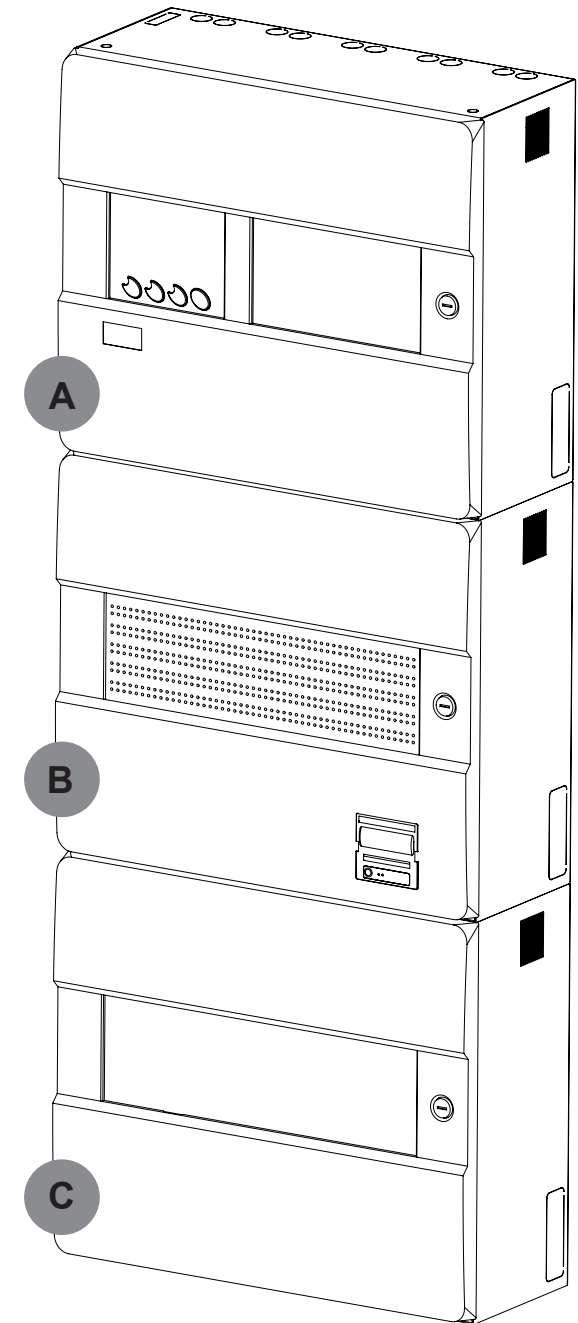

CAD-250 in 'totem' combination with 3 control panels

2. MAIN PANEL

The main panel is located on the left part of the door and consists of a series of lights and basic controls that let you know what is happening in the system at a glance.

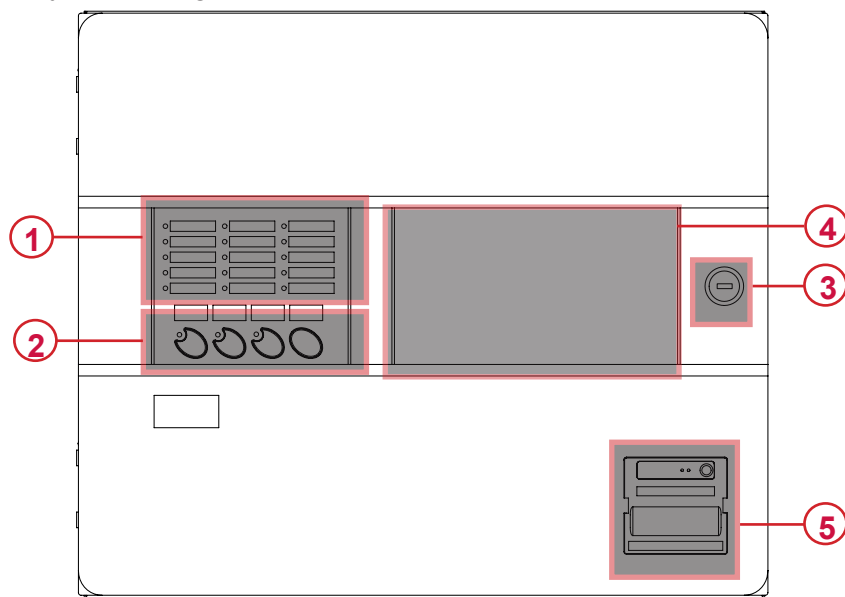





The European standard EN54-2 (UNE 23007-2) sets out the requirements for this panel, including the visual indications, acoustic signals and the behaviour of the obligatory functions.

No.	Area	Description
1	GENERAL LEDS	General state indicators in accordance with the EN54-2 requirements
2	GENERAL CONTROLS	Mandatory general control buttons in accordance with the EN54-2 standards.
3	LOCK	Permits or blocks access to the inside of the control panel. (Acts as access level 3).
4	10" TOUCHSCREEN	Main interface of the CAD-250 control panel.
5	PRINTER	Only available on CAD-250-P: It allows you to obtain a paper copy of the system's events. This device cannot be installed as an option.

2.1. GENERAL LEDS

No.	Condition	Colour/ status	Description
1	SERVICE	Green Permanent	The control panel is powered and works correctly
2	ALARM	Red Permanent	The fire alarm condition is active from any initiator device in the loop
3	CANCEL	Amber Permanent	An element of the system is disabled (device, group, etc.) or there is a delay applied. Normally active together with another general indicator
4	FAULT	Amber Intermittent	Indicates a fault in the system from a loop element, communication ports or the control panel; normally active in combination with other general indicators
5	TEST	Amber Permanent	An element of the system, area or zone is in test mode.
6	OUT OF SERVICE	Amber Permanent	There is a mains network power failure and the battery voltage is less than 20 V.
7	SYSTEM FAULT	Amber Intermittent	There is a power supply issue caused by the network, batteries or fuses
8	POWER SUPPLY FAULT	Amber Permanent	Critical system fault. In this case, the system is not operative.
9	EARTH LEAKAGE FAULT	Amber Intermittent	Some of the system lines are earthed directly or indirectly.
10	RESERVED 1	Amber	Programmable indicator for customisable function
11	TIMED SOUNDERS	Amber	Programmable indicator for customisable function
12	FAULT/ CANCELLED SOUNDERS	Amber Permanent	Programmable indicator for customisable function
13	OUTPUTS CANCELLED	Amber Intermittent	Indicates that there is a fault in the sounder circuit or in a loop sounder
14	RESERVED 2	Amber Permanent	Indicates that there is a control element or relay disabled on the main board.
15	RESERVED 3	Amber	Programmable indicator for customisable function.

2.2. GENERAL CONTROLS

No.	Function	Symbol	Description
16	ACTIVATE SOUNDERS		Press the button to activate the sounders. EVACUATION
17	SILENCE SOUNDERS		Press the button to silence the sounders. The sounders will reactivate if a new alarm event arrives.
18	RELAYS DISABLED		Press the button to silence the acoustic signal of the control panel. The signal reactivates when a new event is received.
19	RESET		Press to reset the system. The control panel will reset all of the alarm and fault conditions; it will also set all of the control activations to zero. If the incidents persist, the activation and operating process will be reactivated again.

2. Main panel

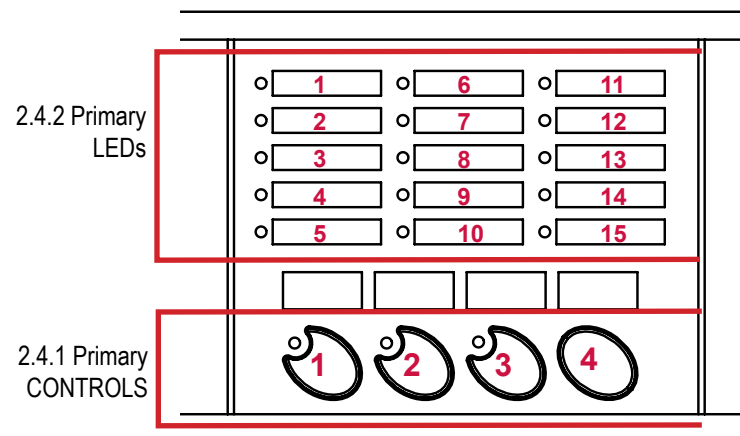
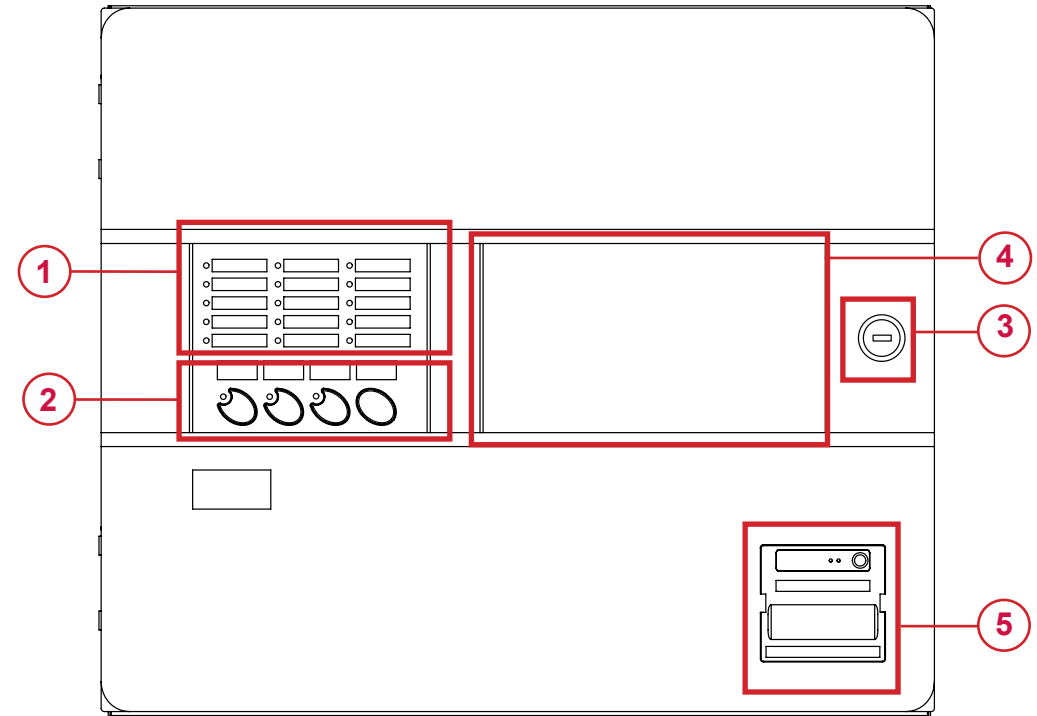

3. USER LEVEL

3.1. STANDBY SCREEN

Until an event occurs in the facility, the system states that it is **IN STANDBY**. In this status, the screen will show:

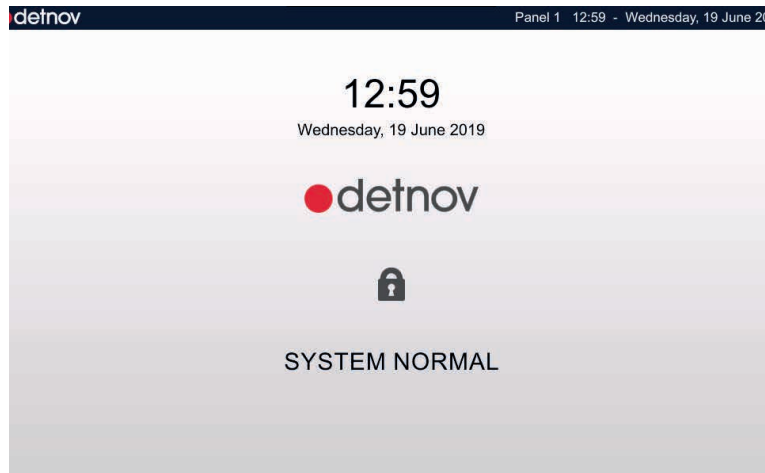

This screen shows the date and time in the **UPPER BAR**, the **CONTROL PANEL NAME** and a padlock. If you touch the padlock (🔒), you will enter the **ACCESS SCREEN**, which will ask you for a security code.

3.2. USER ACCESS

Make sure you have the necessary authorisation and knowledge to operate this control panel, otherwise do not use this level without the supervision of an authorised person..

Depending on the password entered, certain configuration parameters will not be available to prevent improper use of the system.

⚠️ WARNING!: The improper or negligent use of the **USER** access level may cause a malfunction of the facility that can cause the loss of human lives.

If no event has occurred in the facility, the system will be in the **STANDBY SCREEN**.

If you press the padlock (🔒) that appears in the centre of the **STANDBY SCREEN**, you will enter the **ACCESS SCREEN**.

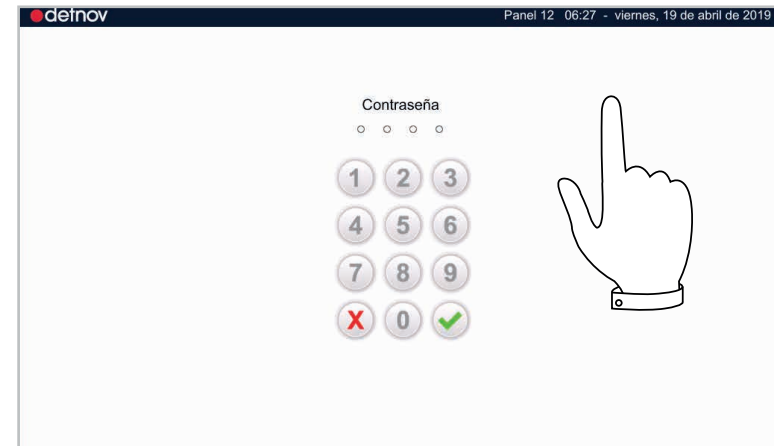

If you are in the **EVENT SCREEN**, press the padlock (🔒) in the upper right corner to enter the **ACCESS SCREEN**.

After pressing the (🔒), the screen menu will show a numeric keyboard for you to enter the password. If you make a mistake when typing it in, press X and re-enter it.

The default user password is **1111**



3.3. USER SCREEN

Once you have entered the password, you will access the **USER MENU**, which is divided into:

No.	Name	Posit.	Description
1	MAIN MENU	Left	Categorises the sections. Loops - Sectors - Manoeuvres - Log - Network - Configuration - Engineering - Maps
2	SUBMENU	Right	Classifies the options for each menu section. It is different for each section.
3	NAVIGATION BAR	Top centre	Browsing elements; they may be TABS, ARROWS or BUTTONS.
4	MAIN VIEW	Centre	Information relating to the chosen menu. It allows the editable fields to be modified via a virtual keyboard. It can show ELEMENT LIST: Ordered in list form. Their features are shown when you press on them. CONFIGURATION TABLE: It shows the information in a table, some of these fields can be editable. GRID: It shows elements in a grid, as well as any value or feature. TREE: It shows Areas, Zones and/or Elements in a tree, as well as any modifiable value or feature. FLOATING WINDOW: It can be shown within the main screen, allowing various actions to be consulted or carried out.
5	STATUS BAR	Top	It shows general information, such as the description of the control panel, the time and date.
6	MESSAGE BAR	Bottom	It shows contextual messages depending on the selected section.

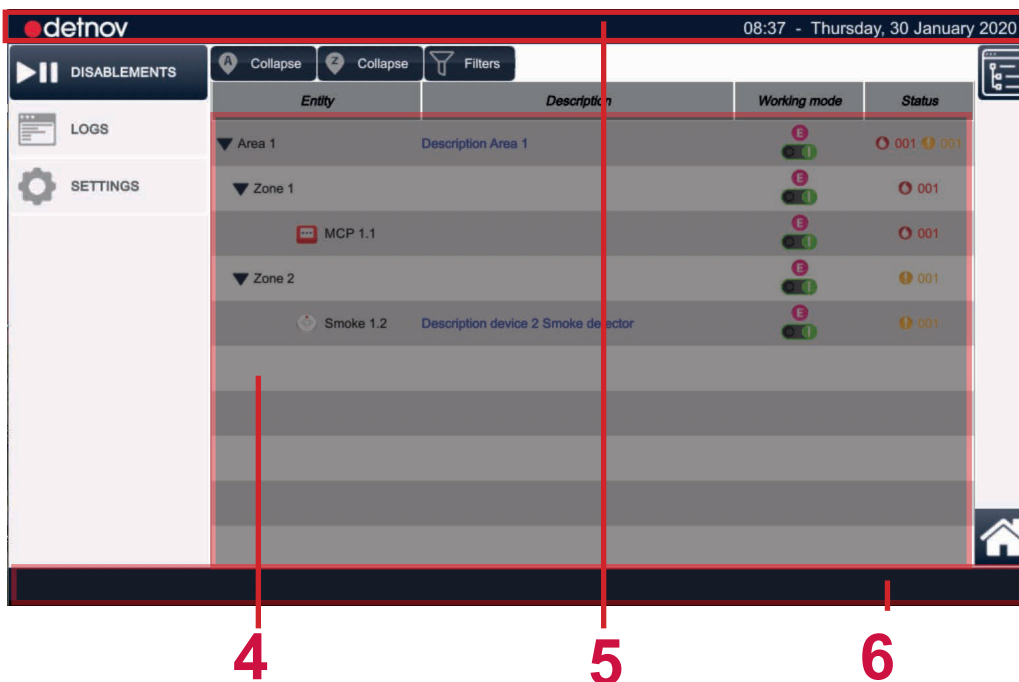
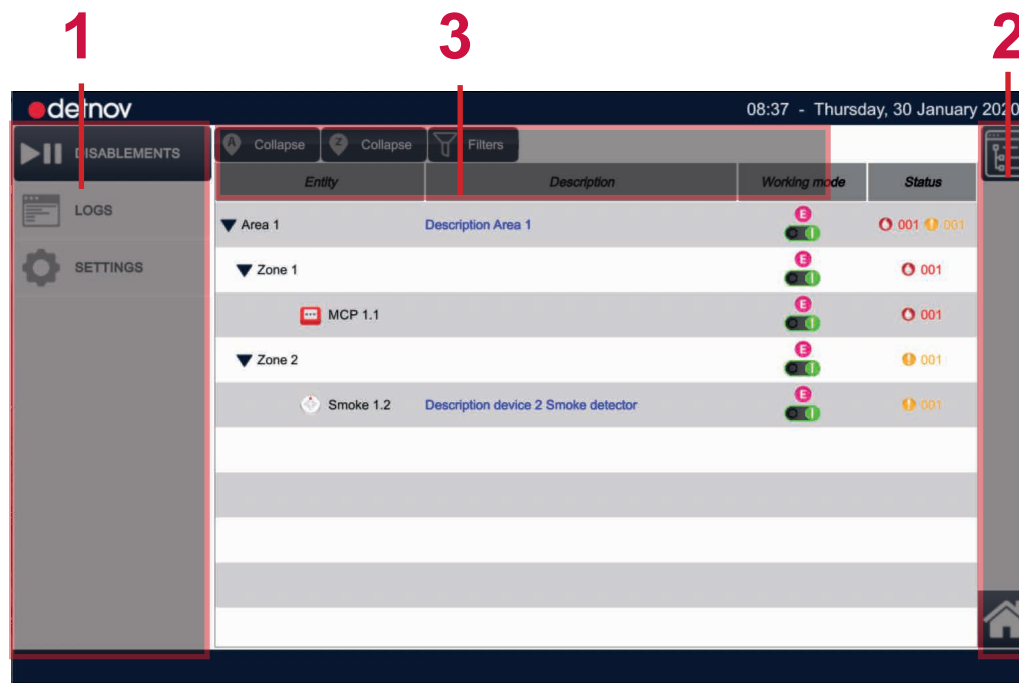

ENG

4. DISABLEMENT MENU

This feature allows you to deactivate a detection facility entity, whether it is an **AREA**, a **ZONE** or a **DEVICE**. To disable a zone, press:

DISABLEMENT (Main menu) > Element tree

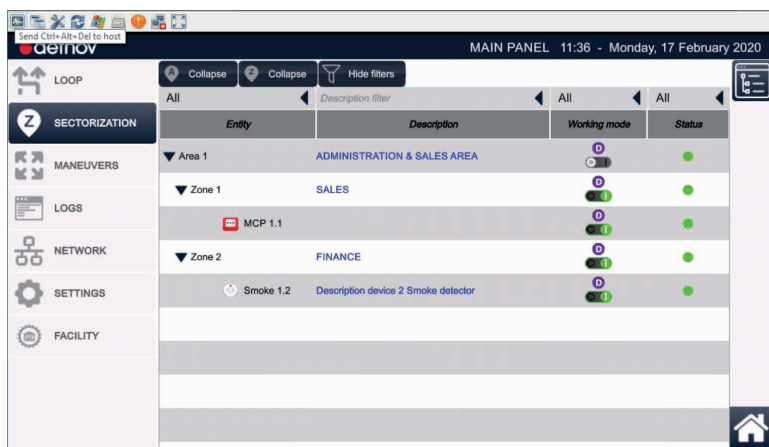

It is a useful feature, for example, if work needs to be done on a part of the building where there is a detection facility.

The ENTITY TREE displays the following information on the main screen:

Entity	Description	Working mode	Status
Area 1	ADMINISTRATION & SALES AREA		
Zone 1	SALES		
	MCP 1.1		

Field	Definition
-------	------------

ENTITY	It shows the entities that make up the facility, Area, Zone or individual device.
--------	---

In terms of the devices, the device type is identified through a characteristic icon and a text. To its right, a numbering appears that indicates 'loop', 'device address'.

DESCRIPTION	Alphanumeric definition assigned for each entity.
-------------	---

WORKING MODE	It indicates the mode in which the facility's entities are operating:
--------------	---

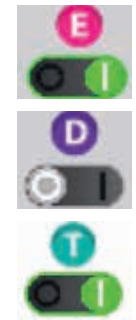

ENABLED:
The events of the elements are monitored.

DISABLED:
The events of the elements are NOT monitored.

TEST:
Intended for the maintenance and inspection tasks of the detection facility.

These alarms will be shown in the **EVENT WINDOW** under the "T" icon for 5 seconds, after which the device will reset and the alarm will disappear.

STATUS	Condition of the device:
--------	--------------------------

- Green** : Normal or in standby
- Red** : Alarm
- Amber** : Fault
- Blue** : Technical event active

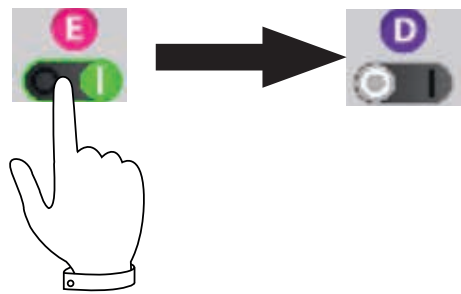

When you press the selector of an entity, the behaviour of all associated entities in the hierarchy will change, being shown with a D (purple, disabled).

On the main screen, there is the **NAVIGATION BAR**, where a series of buttons are shown that enable the following:

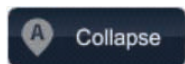

It allows the sectorisation tree of the Area upper hierarchy to be collapsed or expanded.

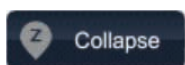

It allows the sectorisation tree of the Zones hierarchy to be collapsed or expanded.

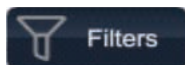

It allows view filters to be applied by type, description, mode or status.

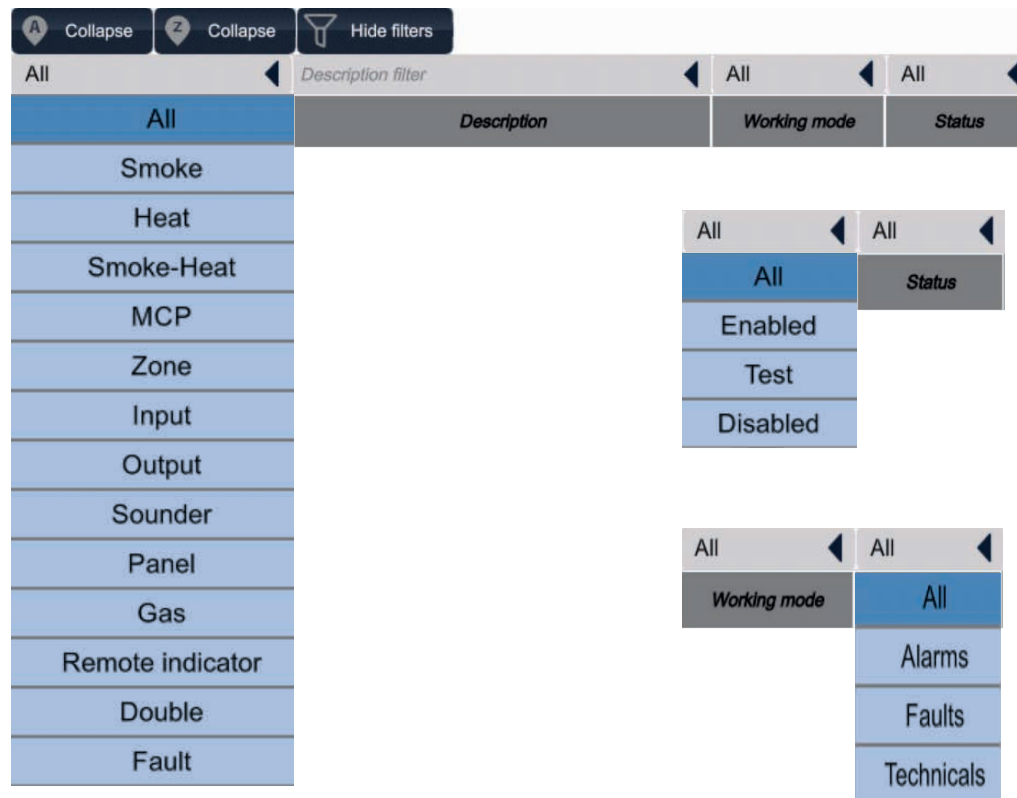

Filter	Definition
ENTITY	It allows you to filter by the device type related to each entity
DESCRIPTION	It allows you to filter by an alphanumeric chain contained in the description of each entity
WORKING MODE	It allows you to filter the tree view by working mode, between All, Enabled, Test and Disabled
STATUS	It allows you to filter the tree view by entity status, between Alarm, Fault and Technical activations.



If you disable an **AREA**, for all the zones and devices contained in that area, the distinguishing status will change to "D", meaning that the events that occur in that AREA will not be monitored.
 If you disable a **ZONE**, the events detected by the devices of that zone will not be monitored.
 If you disable a **DEVICE**, that device will not be monitored.

Make sure the selector of dependent entities does not change. When you re-enable the upper entity. The dependent entities will recover the preset mode according to the position of their selector.

5. LOG MENU (historical event log)

The LOGS section shows you a list of all events recorded by the control panel.

To access the LOGS category, press the **MAIN MENU**:

LOGS



In the **MAIN VIEW**, this log shows the events detected since the last time that the event log, **LOG**, was deleted. They are shown in order of most recent to oldest

In the **SUBMENU** column, the filters per event type are available, Alarm, Fault, Technical signals, Test and Information.

From the **NAVIGATION BAR**, it is possible to jump to the following pages in the event list or to filter by a date range.

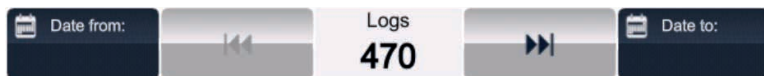

The system will not save the events of devices, zones or areas that are disabled.

The **EVENT LIST** shows the following information, ordered from most recent to oldest:

Field	Definition
ID	Event identifier, event sequence number.
DATE	Date and time when the event occurred.
TYPE	Event typology, corresponds to the types of filter in the submenu

	ALARM Fire alarm events
	FAULT OR FAILURE Fault events of any system element
	TECHNICAL ACTIVATIONS Events caused by the activation of technical signals, which are not a fire alarm detection
	TEST Zone or area events when configured in test mode
	INFORMATION General events, such as access, area or zone changes or actions on general control function keys, such as RESET, SILENCE, etc.

DESCRIPTION	The system generates a description of the event
-------------	---

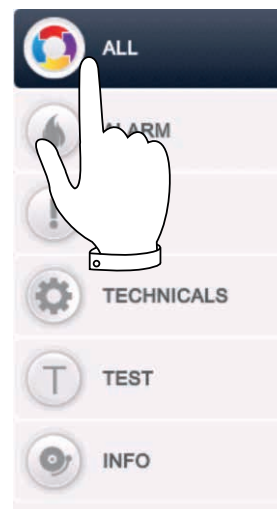

When selecting each option on the **SUBMENU**, you can filter the events by the corresponding types for better analysis.



The **"ALL"** button is active by default and all log events are shown

When filtering the event type, the NAVIGATION BAR counter will also update its value. Click one of the filter options on the submenu to view:

ID	Date	Type	Description
470	2020-01-30 08:44:14	ALARM	User (3): has disabled zone (1):

ALL: All events are shown.



ID	Date	Type	Description
469	2020-01-30 08:44:06	ALARM	MCP alarm at device (1.1): at zone (1): area (1): Description Area 1
461	2020-01-30 08:25:32	ALARM	MCP alarm at device (1.1): at zone (1): area (1): Description Area 1

ALARMS: Only the alarms are shown.



ID	Date	Type	Description
460	2020-01-30 08:23:24	FAULT	Device removed at device (1.2): Description device 2 Smoke detector at zone (2): area (1): Description Area 1
441	2020-01-22 05:33:02	FAULT	Panel: fault: battery fault
439	2020-01-13 19:01:53	FAULT	Panel: fault: battery fault

FAULT: Only the faults are shown.



Date	Type	Description
2019-12-03 11:31:14	TECHNICALS	Módulo virtual 1 Desactivado
2019-12-03 11:31:13	TECHNICALS	Módulo virtual 1 Activado

TECHNICAL: Events that occur on technical inputs are shown.



Date	Type	Description
70	2020-01-30 08:44:14	User (3): has disabled zone (1):
68	2020-01-30 08:44:03	User (2): has enabled device (1.1): at device (1.1): at zone (1): area (1): Description Area 1
67	2020-01-30 08:44:01	User (2): has enabled zone (1):
66	2020-01-30 08:43:08	User (3): has disabled zone (1):
65	2020-01-30 08:43:02	User (3): has disabled device (1.1): at device (1.1): at zone (1): area (1): Description Area 1
64	2020-01-30 08:42:12	User (2): User role has entered the menu
63	2020-01-30 08:37:36	User (2): User role has entered the menu

TEST: The events of ZONES and AREAS configured in TEST mode are shown.



Date	Type	Description
70	2020-01-30 08:44:14	User (3): has disabled zone (1):
68	2020-01-30 08:44:03	User (2): has enabled device (1.1): at device (1.1): at zone (1): area (1): Description Area 1
67	2020-01-30 08:44:01	User (2): has enabled zone (1):
66	2020-01-30 08:43:08	User (3): has disabled zone (1):
65	2020-01-30 08:43:02	User (3): has disabled device (1.1): at device (1.1): at zone (1): area (1): Description Area 1
64	2020-01-30 08:42:12	User (2): User role has entered the menu
63	2020-01-30 08:37:36	User (2): User role has entered the menu

INFORMATION: Log of accesses to the control panel, zone/area mode changes and physical keys pressed.



6. SETTINGS MENU

The settings category allows you to consult basic operating parameters of the control panel. To access the category, press:

SETTINGS (Main menu) > **GENERAL** (Submenu)

6.1. GENERAL

The GENERAL submenu is active by default and has 2 TABS:

6.1.1. Miscellaneous

SETTINGS (Main menu) > **GENERAL** (Submenu) > **MISCELLANEOUS** (Tab)

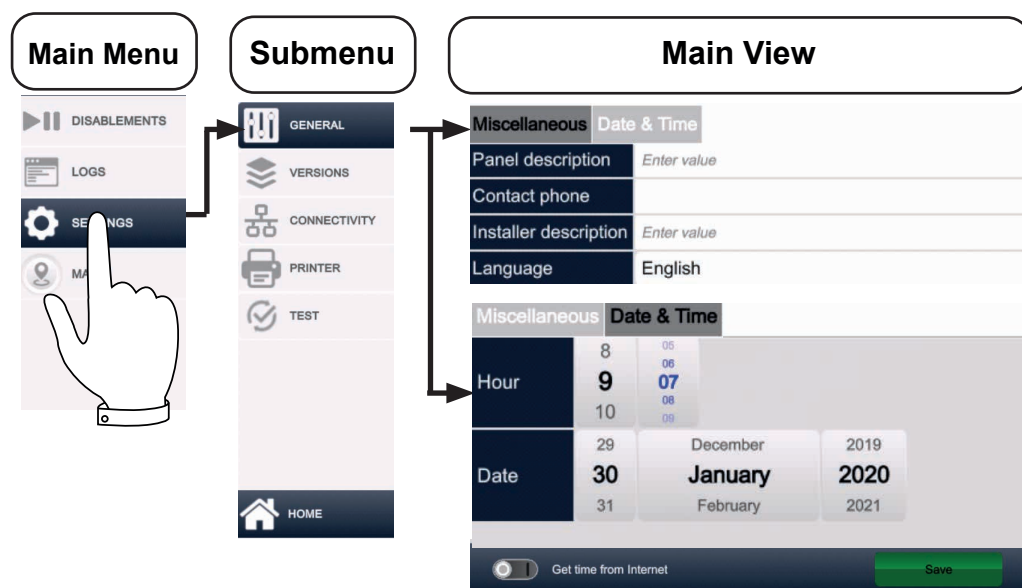

The Miscellaneous tab on the general submenu shows the **CONFIGURATION TABLE**, in which the following information can be consulted:

Field	Definition
PANEL DESCRIPTION	Name assigned to the control panel.
CONTACT PHONE	This contact phone will be shown in the EVENT MANAGER when a fault is detected.
INSTALLER DESCRIPTION:	Installer information that will be shown in the EVENT MANAGER when a fault is detected
LANGUAGE	Current control panel language



If any of this data is not configured, notify the person responsible for the system so that they complete the information.

6.1.2. Date

SETTINGS (Main menu) > **GENERAL** (Default submenu) > **DATE AND TIME** (Tab)

In this section, the date and time of the system will be defined.

If the system is connected via the RJ45 port to an Ethernet network with Internet access it is possible for the time to be updated automatically; for this, activate the option:

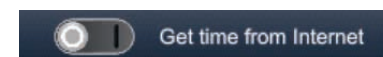

Press , **SAVE** to update the settings.



CAUTION: Take into account that the system date is used by certain manoeuvres, so if you modify it incorrectly, they may be executed erroneously.



If you connect the control panel to the Internet via the RJ45 port, you can activate the "Update time from Internet" option, so that the time updates automatically. This option may not work in some countries.

6.2. VERSIONS

The version menu shows the software installed in the different components of the control panel. To access the submenu, press:

SETTINGS (Main menu) > **VERSIONS** (Default submenu)

This submenu allows you to consult the following values:

Field	Definition
SOFTWARE VERSION	Control panel software version.
HARDWARE VERSION	It shows the version of the additional cards connected to the control panel

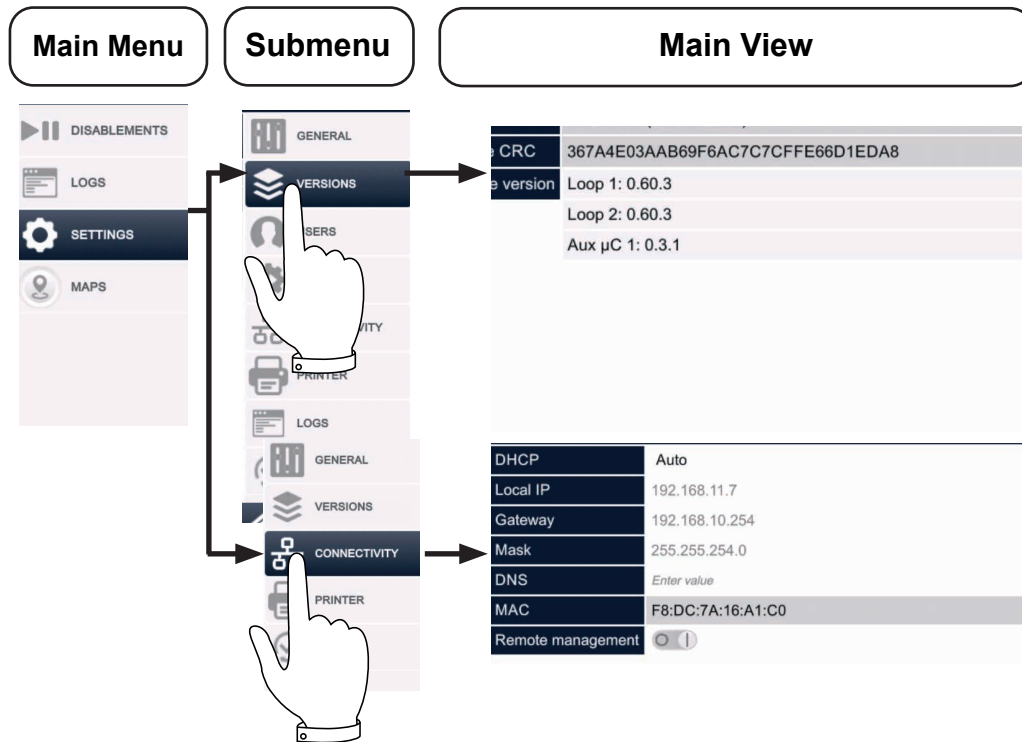

6.3. CONNECTIVITY

From this section, the IP network configuration parameters of the control panel can be consulted. To access the submenu, press:

SETTINGS (Main menu) > **CONNECTIVITY** (Submenu)

This section allows you to check:

Field	Definition
DHCP MANUAL/AUTO	The assignment of the control panel IP address is manual or automatic.
LOCAL IP	IP address of the control panel.
GATEWAY	IP address of the gateway
MASK	IP address of the subnet mask.
DNS	IP address of the domain name system.
MAC	This field shows the MAC (Media Access Control) of the control panel network adapter.
REMOTE CONTROL (ON/OFF)	If it is activated, you can remotely access the control panel.

6.4. PRINTER

If your control panel model is the CAD-250-P, this submenu will be available. To access the SETTINGS category, press:

SETTINGS (Main menu) > **PRINTER** (Submenu)

This submenu has two tabs.

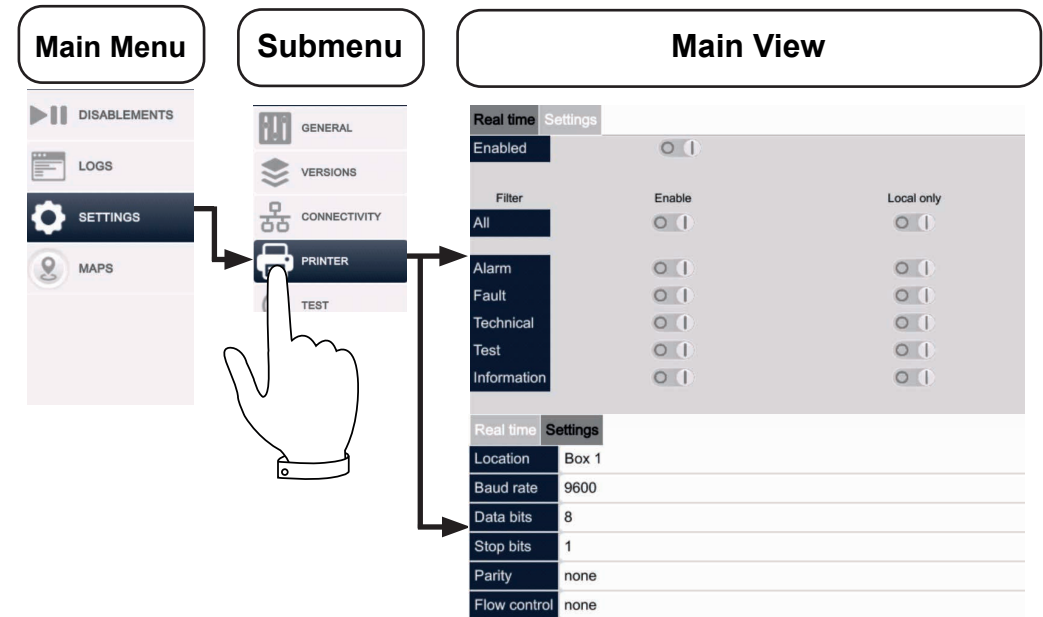

6.4.1. Printer

The printer screen shows a series of parameters that can be activated via selectors.

To activate the event output by the printer, press:

ENABLED: It activates the event output by the printer.

The printable information is divided into two columns: if you have a network of CAD-250 control panels, you can choose whether to print all system events, **ENABLE** selector, or just the events of the panel you are configuring, **LOCAL ONLY** selector.

Option	Definition
ENABLE	ENABLES printing for all system events or for the event type selected, see table below
LOCAL ONLY	If the control panel is networked, when you mark this option, it will only print the control panel events and will filter out any events from other networked control panels.

From each column, you can select what information to print:

Option	Definition
ALL	This filter activates the printing of all events
ALARM	Activates the alarm event output.
FAULT	Activates the printing of faults.
TEST	Activates the printing of events from tests.
INFORMATION	Activates the printing of all events.

6.4.2. Configuration

In the configuration screen, you can consult the connection data of the printer.

Field	Definition
LOCATION	It shows which cabinet the printer is installed in if the control panel consists of more than one section. Box 1 will indicate that it is the upper cabinet containing the first loop
BAUD RATE	It shows the communication speed of the printer. By default: 9600

Field	Definition
DATA BITS	It shows the number of data bits. By default: 8
STOP BITS	It shows the number of stop bits. By default: 1
PARITY	It shows whether your printer is configured WITH or WITHOUT parity. By default: Without
FLOW CONTROL	It shows whether your printer has flow control. By default: Without

6.5. PANEL TEST

To access the TEST submenu, carry out the following steps:

SETTINGS (Main menu) > **TEST** (Submenu) >
> **START** (Button in the middle of the screen)

During the test process, you should check that the LEDs of the MAIN PANEL and the screen work correctly.

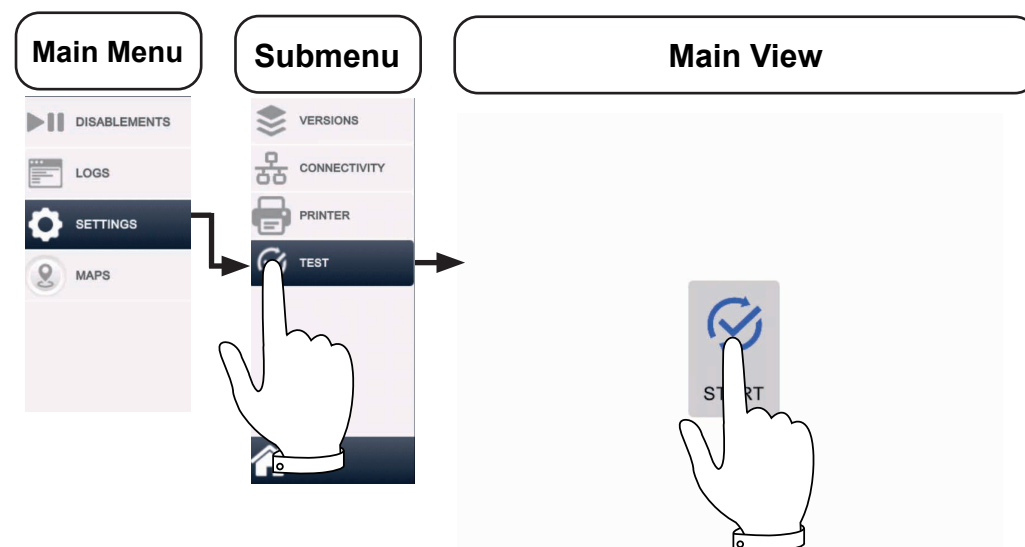

7. MAINTENANCE

7.1. LOG

According to the recommendations of the EN54 Part 14 standard, you should create a log in which you can record the following information:

7.2. PERIODIC TESTS

To ensure the system is fully operational and to comply with the requirements of EN54 Part 14 and BS5839 Part 1: 1998, you should carry out the following recommendations periodically:

DAILY: Check the panel does not indicate any fault. Otherwise, record it in the log, as well as the measures taken, for example, informing the maintenance company.

WEEKLY: As a minimum, test a sensor or manual call point to confirm the panel and acoustic alarms are working. Test a different zone, and if possible also a unit, each week. Keep a log of the unit and zone tested each week. Record and report any anomaly.

QUARTERLY: Every three months you should check:

- The log entries and the measures taken.
- The batteries in standby and the charger voltage.
- As a minimum, one unit from each zone to check the functions of the panel.
- The functioning of the acoustic alarms and any connection to a remote control centre, central station, etc.
- Perform a visual inspection of the facility to check for any alterations or obstructions and prepare a test certificate.

ANNUALLY: The person responsible must ensure that, as well as the quarterly checks, each unit of the system is tested and a visual inspection of the wiring and equipment is performed.

7.3. CLEANING

The control panel must be cleaned regularly with a soft cloth dampened with water. Do not use solvents.

7.4. LOG.

(Log proposal according to UNE23007/14:2014

A person responsible for monitoring all entries to this log should be appointed. The name of this person (and all changes of person responsible) should be recorded.

Reference data

Name and address:

.....

Person responsible: Date:.....

Date:.....

Date:.....

Date:.....

The system was installed by:.....

and its maintenance is carried out according to the contract with:

.....

until

Call this phone number if service is required.

All events (including fire alarms, false alarms, faults, pre-alarm warnings, tests, deactivations, temporary disconnections, service visits and any other significant event) must be recorded correctly. A brief note about any work carried out or pending should be included

LOG

Date	Time	Alarm counter reading	Incident	Action required	Person responsible	Completion date

Consumable components:

.....

.....

.....

Date on which they must be replaced:

.....

.....





.....



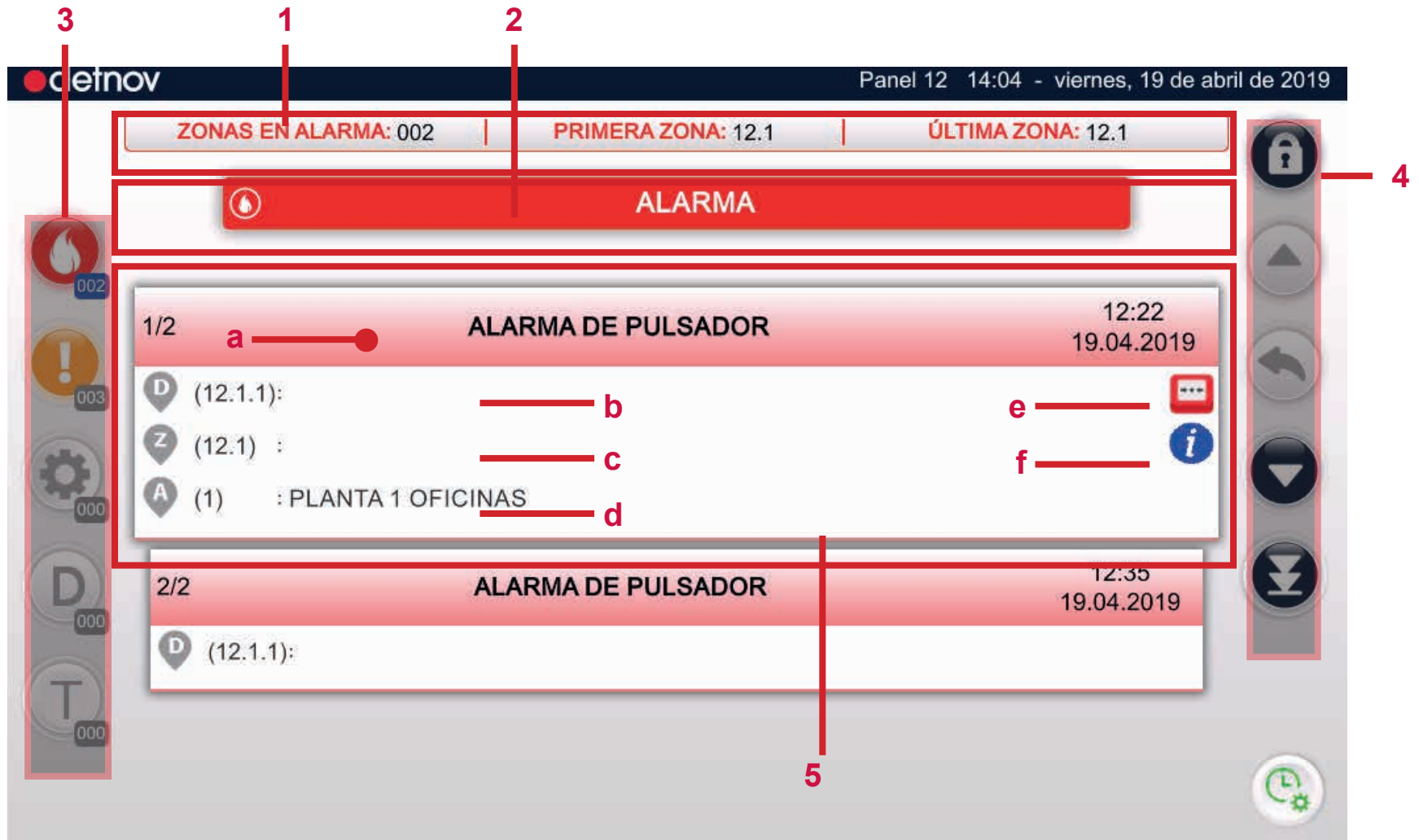



8. EVENT SCREEN

If an event occurs in the facility, the STANDBY SCREEN will change to this window. The EVENT SCREEN is an environment that shows the events (alarms, faults, disablements, etc.) that are being detected in the facility. The screen is divided into various zones:

No.	Name	Description
1	ALARM BAR	It shows if there is an active alarm, according to the EN54-2 standard. It includes a zones in alarm counter; the first zone in alarm and the last zone in alarm.
2	STATUS BAR	The status bar only shows which event list you are in, the types of event it shows may be: ALARM, FAULT, TECHNICAL, DISABLED, TEST.



No.	Name	Description
3	STATUS COLUMN	List filters according to status. Each icon includes a counter that indicates the number of active events for each status.
		 The icon is highlighted when the counter shows 1 or more alarms. By touching the icon, the event list is filtered by that status
		 The icon is highlighted when the counter shows 1 or more faults. By touching the icon, the event list is filtered by that status
		 The icon appears highlighted when the counter indicates 1 or more active technical signals from input modules configured as technical input. By touching the icon, the event list is filtered by that status
		 The icon appears highlighted when the counter indicates 1 or more disabled entities. By touching the icon, the event list is filtered by that status. By touching the icon, the event list is filtered by that status.
		 The icon appears highlighted when the counter indicates 1 or more entities in test status. By touching the icon, the event list is filtered by that status. The test mode is used to carry out maintenance tasks. The recorded events are not considered alarms and the devices will reset automatically a few seconds after being triggered.

No.	Name	Description
4	NAVIGATION	On the right side of the screen there is a column of navigation icons
		 It allows access to higher user and configuration levels
		 Scroll up the list; by touching it, the previous incident will be shown successively.
		 An item is highlighted only if technical events are detected, pressing it returns you to the standby screen
		 Scroll down the list; by touching it, the following incident will be shown successively.
		 If you are in the last event, it will return you to the first one and it will take you to the last one if you are in the first
		 It shows the supplier's contact information if a fault has occurred and if it was defined from the configuration menu.
		 It is highlighted if special modes are activated. When you touch the icon, a list of modes that have been configured is shown.

5	EVENT WINDOW	a EVENT BAR: it describes the type of event, as well as the date and time it occurred.
		b DEVICE IDENTIFICATION: a number that codifies the device's position in the loop appears next to the icon ('control panel identification', 'loop identification', 'device address') and the description of the device.
		c ZONE IDENTIFICATION: It shows the panel number and the zone that codifies the device's position in the loop, as well as the current description of the zone
		d AREA IDENTIFICATION: It shows the area number and description associated with the event identified.
		e DEVICE TYPE: it graphically identifies the device type.
		f EVENT INFORMATION: Icon highlighted and active when there is additional information regarding the event. By touching the icon, the CONFIGURATION TABLE opens with information regarding the event, which allows certain parameters to be changed.

9. TROUBLESHOOTING

This section aims to respond to the most common faults and problems you may come across when installing a CAD-250 control panel.

9.1. FAULTS SHOWN ON THE PRIMARY CONTROLS

The LEDs and primary controls of the CAD-250 control panel allow the user to know the status of the facility quickly and to initiate a series of actions easily. These LEDs normally indicate anomalies in the detection network or control panel.



The European standard EN54-2 sets out the minimum requirements for this panel, including the buttons, visual and audible indications and its behaviour.

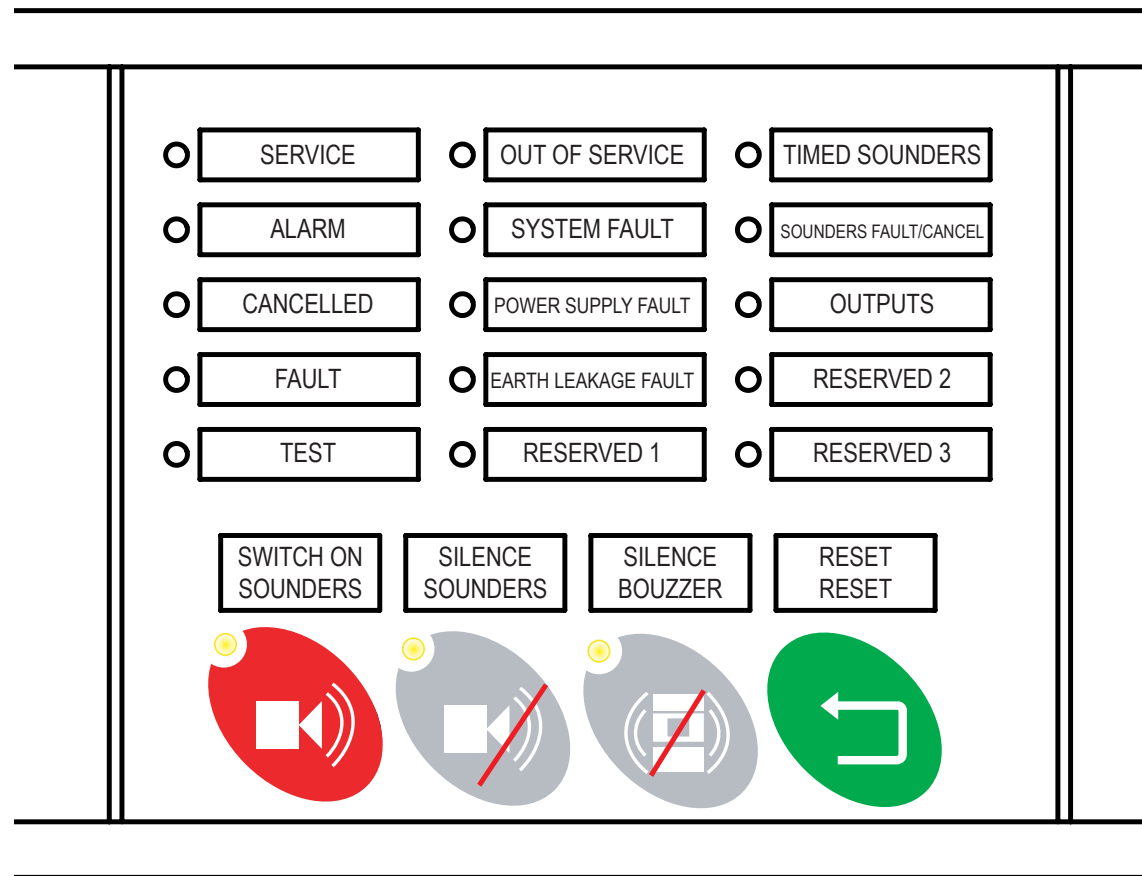

9.2. FAULTS SHOWN ON THE EVENT SCREEN

Under the FAULTS icon in the EVENT SCREEN, the different system faults are shown. Below is a list of errors, causes and solutions for each of them:

LEDS	CAUSE	SOLUTION
SERVICE (Green)	Switched on whenever the control panel is operating and powered.	If there is no power or it is out of service, the LED will switch off.
ALARM (Red)	Switched on whenever an event or alarm is detected.	Switched off if the control panel has no alarm event.
OUT OF SERVICE (Amber)	Switches on when the control panel has no power and the battery voltage is equal to or lower than 20 V.	Switched off when it is in service and there are no issues with the power supply.
CANCEL (Amber)	Switched on when a device is disabled, such as the buzzer or any disabled device.	When there is no disablement or cancellation of the buzzer.
TEST (Amber)	Switched on when a device/zone/area is in test mode.	Remains off if nothing is in test mode
FAULT (Amber - flashing)	Flashes when a fault occurs.	Stops flashing when there is no fault
SYSTEM FAULT	The microprocessor has stopped delivering pulses to the WatchDog, meaning that it is down.	If it is off, it means there is no problem regarding communication with the central processing unit or CPU.
POWER SUPPLY FAULT	It activates when a fault occurs in the batteries or the power supply.	Off when everything is working correctly in terms of the batteries and the power supply.
EARTH LEAKAGE FAULT	When the control panel detects an earth potential that is positive relative to GND.	Off when the condition that switches it on is not met.
TIMED SOUNDERS	It switches on when a delay or sounder is applied, whether from the PCB or a loop device.	If there is no delay associated with the sounders
SOUNDERS FAULT/CANCELLED	It switches on and flashes if there is a fault on any of the sounders. The FAULT LED also flashes. It switches on permanently, as does the CANCEL LED, when the disablement involves a sounder.	Off when neither of the previous two premises is met.
CANCELLED OUTPUTS	It switches on permanently when an output is disabled and is always accompanied by the CANCEL LED. For example, when an output module is disabled.	It is switched off when there is no output device disabled.

Under the FAULTS icon in the EVENT SCREEN, the different system faults are shown. Below is a list of errors, causes and solutions for each of them:

DEVICES	CAUSE	SOLUTION
OPEN FAULT	This fault is due to the lack of end-of-line monitoring of some devices with this feature. For example, the input modules where monitoring mode can be configured with a switch. Where via an end-of-line resistor, "open fault" is indicated if it is not present.	Replace the end-of-line monitoring or change the switch and do not carry out the monitoring.
24 V FAULT	A loop device needs 24 V power, such as certain input/output modules or a zone module, and this is not being carried out correctly.	To resolve it, repower the device correctly.
SHORT-CIRCUIT FAULT	There is a short circuit in an input device or zone module.	Check the affected device and undo the short circuit.
DOUBLE ADDRESS FAULT	There are two devices with the same address in one loop.	Change the device address to another that is free.
DEVICE REMOVED	A device has been removed from the loop	Carry out an auto search or change the device type again from the configuration software to the correct type.
TYPE FAULT	An incorrect type has been assigned to one of the facility's devices with the configuration software. For example, there is a detector installed on address 1 of loop 1, but with the software, a manual call point was assigned to that address.	Carry out an auto search or change the device type again from the configuration software to the correct type.
DIRTY FAULT	Dirty fault due to a dirty detector. This fault is activated because the option: FACILITY > LOOP > DIRTINESS NOTIFICATION is activated.	Change the control panel's configuration so that it does not detect this fault or it cleans the detector.
UNCONF FAULT	A device has been introduced in a loop without previous configuration, although it is correctly addressed and the option: FACILITY > LOOP > NOT CONFIGURED NOTIFICATION is activated.	Remove the device or carry out a new auto search of the affected loop.

LOOPS	CAUSE	SOLUTION
OPEN SOUNDER FAULT 1 OR 2	The end of line (4K7 resistor) of the sounders is not detected.	Fit the end-of-line resistor to ensure proper monitoring.
SHORT-CIRCUIT IN SOUNDER FAULT	There is a short circuit on sounder outputs 1 or 2 of the PCB.	Locate the short circuit
24 V OUTPUT FAULT	The 24 aux 0.5 A fuse on the PCB is blown.	Change the fuse.
BATTERY FAULT	The control panel detects that there is no battery and the option: FACILITY > LOOP > BATTERY FAULT is activated.	Change the battery
BATTERY CHARGER FAULT	It is generated when the control panel detects that the drop on the battery terminals is more than 3 ohms.	Check and correctly connect the power supply
EARTH FAULT	The control panel detects that there is an earth leakage and the option FACILITY > LOOP > EARTH FAULT and JUMPER JP7 are activated.	Look for the earth leakage point.

LOOPS	CAUSE	SOLUTION
MAIN POWER FAULT	Power supply fault	Check the power input fuse, the position of the electrical protection element lever and/or the mains power supply.
HIGH TEMPERATURE	The charger temperature is above the maximum	Check the battery connections.
OUT OF SERVICE	When the control panel is without power and the battery charge is below 20 V and is close to switching off.	Reconnect the power supply.
ISO OPEN FAULT (S) OR (R)	The loop is open. The fault indicates whether the fault is on the output (O) or return (R) of the loop, or on both.	Locate and repair the fault in the loop.
ISO SHORT FAULT (S) OR (R)	There is a short circuit in the loop. The fault indicates whether the short circuit is on the output (O) or return (R) of the loop.	To resolve it, repower the device correctly.

10. TECHNICAL SPECIFICATIONS

This fire control panel meets the subsections of the following European standards: EN 54-2:1997,

EN 54-2:1997/AC:1999,

EN 54-2:1996/A1:2006

EN-54-2	SUBSECTION	
General requirements	4.	PASS
General requirements for the indications	5.	PASS
Standby state	6.	PASS
Fire alarm state	7.	PASS
Fault warning state (annex F)	8.	PASS
Disconnected state	9.	PASS
Test state (option with requirements)	10.	PASS
Design requirements	12.	PASS
Additional design requirements for control and indication units controlled by the software	13.	PASS
Marking	14.	PASS
Cold (operational)	15.4	PASS
Damp heat, steady state (operational)	15.5	PASS
Impact (operational)	15.6	PASS
Vibration, sinusoidal (operational)	15.7	PASS
EMC immunity	15.6	PASS
Variation of the supply voltage	15.13	PASS
Damp heat, steady state (endurance)	15.14	PASS
Vibration, sinusoidal (endurance)	15.15	PASS

The CAD-250 control panel was designed, manufactured and certified in accordance with the subsections of the following European standards:

EN 54-4:1997,

EN 54-4:1997/AC:1999,

EN 54-4:1997/A1:2002,

EN 54-4:1997/A2:2006

EN-54-4	SUBSECTION	
General requirements	4.	PASS
Functions	5.	PASS
Materials, design and manufacturing	6.	PASS
Documentation	7.	PASS
Marking	8.	PASS
Cold (operational)	9.5	PASS
Damp heat, steady state (operational)	9.6	PASS
Impact	9.7	PASS
Vibration, sinusoidal (operational)	9.8	PASS
Electrostatic discharges (operational)	9.9	PASS
Damp heat, steady state (endurance)	9.14	PASS
Vibration, sinusoidal (endurance)	9.15	PASS

MECHANICAL SPECIFICATIONS

MATERIALS: Iron sheet housing with a thickness of 1.2 mm. ABS front with V0 fire resistance

DIMENSIONS: Maximum measurements of the control panel (in mm):
Width: 533 / Height: 450 / Depth: 225

WEIGHT: Without batteries: 12.5 kg
With NP24-12 batteries: 30.5 kg

ENVIRONMENTAL SPECIFICATIONS

CLIMATE CLASSIFICATION: 3K5, (IEC 721-2-3)

OPERATING TEMPERATURE: from -5°C to +40°C

HUMIDITY: from 5% to 95% RH

PANEL PROTECTION: IP 30, (EN 60529)

EMC (electromagnetic compat.): Immunity EN 50130-4

INDICATION SCREEN

10" TOUCHSCREEN: IPS, 1024x600 pixel resolution, 300 dpi touch resolution

PRIMARY INDICATORS: Service, Alarm, Disabled, Fault, Test, Out of service, Power supply fault, System fault, Earth leakage, Sounder delay, Sounder fault/disablement, Disabled relays.

ZONE INDICATORS (Optional): 250 alarm indications and 250 fault indications

CONTROL KEYS

PRIMARY CONTROLS: Switch On Sounders, Silence Sounders, Silence Buzzer, Reset.

EXTERNAL CONNECTIONS: 2 USB ports, 1 Ethernet port
1 RS232 port for printer

CABLE ENTRIES: 28 entries with a diameter of more than 23 mm
421 x 55 mm on the back

EXPANSION INPUTS: 2 (upper and lower) measuring 50 mm x 15 mm

CONDUIT ENTRIES: 2 side entries (left and right) measuring 100 mm x 35 mm

EXTERNAL POWER INPUTS: Rear input measuring 50 x 74 mm
Lower input measuring 35 x 75 mm

ELECTRICAL SPECIFICATIONS

CLASSIFICATION: Class I facility (the panel must be earthed)

POWER SUPPLY: 88 V-264 V~(ac),
3 A (110 V), 2 A (230 V)

FUSE: 4 A

INTERNAL BATTERIES: 24 Ah-12 V

OUTPUTS: 2 Sounder outputs / 2 Fault outputs / 1 Auxiliary output of 24 V / 8 Loop outputs (optional)

SOUNDER OUTPUT VALUES

TYPE: Inverted voltage.

OUTPUT VOLTAGE: active 26 to 28 V / inactive -6 V to -7 V

MAXIMUM LOAD: 0.45 A

FUSE: 0.5 A

MONITORING: Open circuit and short circuit

RELAY OUTPUT VALUES

TYPE: Single pole changeover switch

MAXIMUM LOAD: 28 V 10 A contacts

FUSE: 0.5 A

24 V AUXILIARY OUTPUT VALUES

OUTPUT VOLTAGE: 26 to 28 V

LOOP OUTPUTS

OUTPUT VOLTAGE: 26 Vdc to 33 Vdc (Detnov protocol)

MAXIMUM LOAD: 0.45 A

MAXIMUM DEVICES/LOOP: Up to 250 devices (*)



(*) The number of elements may be limited by local requirements, system autonomy and the requirements of the emergency plan.

Take into account the consumption of the devices at the most unfavourable time, for e.g. alarm or evacuation in relation to the maximum current of the loop and the necessary autonomy.



The specifications and features described in this manual may be subject to modification without prior notice by the manufacturer.

