

ReSet Call Point - Flush (RF2) or Surface (RS2 & RD2) Mount - Series 01, 02 & 11

'ReSet' is a unique fire alarm manual call point that mimics the feel of breaking glass whilst offering the user the benefits and safety advantages of a glass-free resettable operating element. Once activated a warning flag drops in to view easily identifying the call point that has been operated. A key can then reset the unit. The 'ReSet' provides an ideal solution for most conventional fire alarm systems. It is ideal for industries that are sensitive to broken glass as well as areas that suffer from a high number of false activations such as schools, shopping centres and other public places.

Dia A.

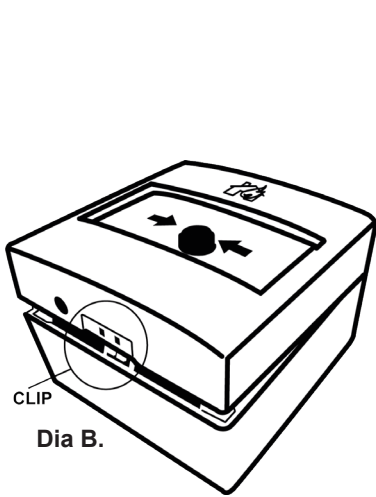
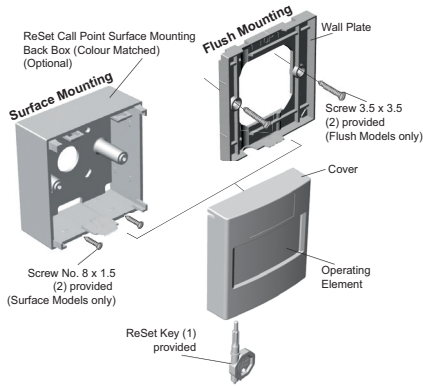
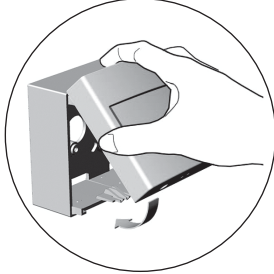

Dia B.

Step 1
Carefully attach the ReSet Call Point to the top of the back box (Dia A.) and hinge down to the points where the cover rests on the top of the clip (Dia B.)

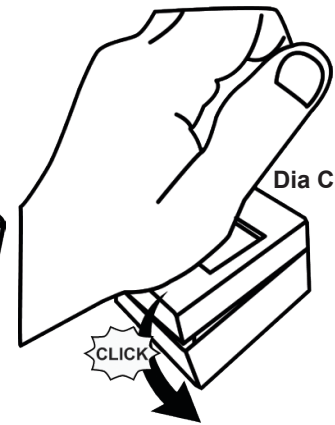

Dia C.

Step 2
Firmly push down on the cover to engage with clip. This should create a positive clicking sound which ensures that the clip has been correctly engaged (Dia C.)

NB: If unsure if the clip has engaged with the back box, ***IMPORTANT*** release the cover following Step 3. When back in the position demonstrated in Dia B. repeat Step 2.

Dia D.

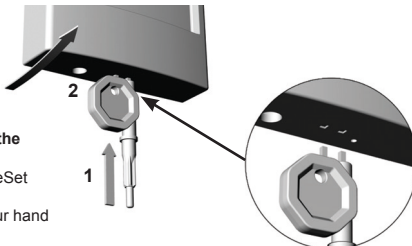

Step 3 - Detaching the cover from the back box

1. Insert key into the bottom of the ReSet cover
2. Keep the key inserted and with your hand pull the cover towards you (Dia D.)

Connection Options for ReSet Call Point Series 01

ReSet Series 01 Configuration

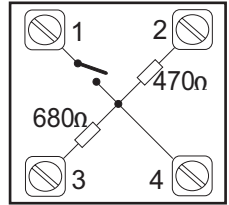

Option 1 terminals 1 & 2

Normally open switch closing on alarm with a 470 ohm resistor fitted in series with the switch

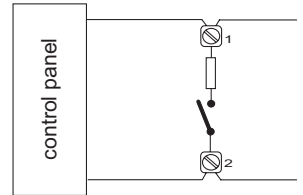

Option 2 terminals 1 & 3

Normally open switch closing on alarm with a 680 ohm resistor fitted in series with the switch

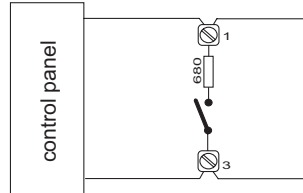

Option 3 terminals 1 & 4

Normally open switch closing on alarm ***IMPORTANT*** This configuration is **not EN54-11 compliant** and unsuitable for use with EN54-2 compliant conventional control panels

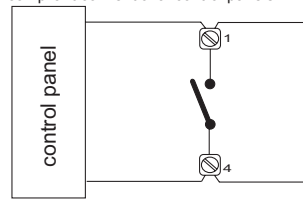

Technical Data for ReSet Call Point - Flush (RF2) or Surface (RS2 & RD2) Mount - Series 01, 02 & 11

Mounting Method

Surface Installations

NB: For security reasons the ReSet call point is deliberately difficult to remove from the back box once fitted. Please ensure that the ReSet call point is installed correctly before snapping closed.

The ReSet call point can be supplied complete with its own surface mounting back box, 20mm entry holes can be easily drilled. (See Dia B below).

With the screws provided, fix the back box to the wall. Carefully attach the ReSet call point to the top of the back box, hinge down to snap securely into place.

B



Flush Installations

Flush models are available. The ReSet Call Point is provided with a wall plate that is designed to fit directly onto a standard UK single 35mm deep flush box. Contact sales on for further details on +44 (0)1527 520 999.

ReSet Series 01, 02 & 11

Series 01

Denotes a ReSet call point that will interface with most conventional fire alarm systems. It is fitted with two internal resistors 470 ohm and 680 ohm. These are easily accessed through the installer terminals as illustrated.

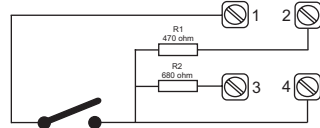

Series 02

Denotes a ReSet call point that is fitted with a single pole changeover switch both the normally open and normally closed contacts are easily accessed through the installer terminals as illustrated.

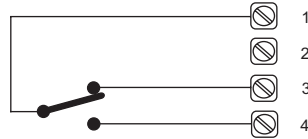

Series 11

Denotes a ReSet call point that incorporates two independent single pole changeover switches providing double pole changeover contacts. Easily accessed through installer terminals as illustrated.

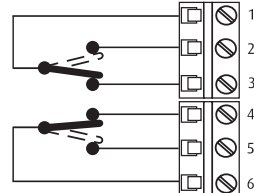

NB: Switch arrangements shown with ReSet in standby.

Dimensions

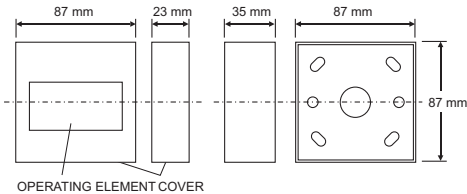

ReSet Series 01



Safety Technology International

Taylor House, 34 Sherwood Road

Bromsgrove, Worcestershire, B60 3DR, England

Tel: +44 (0) 1527 520 999 Fax: +44 (0) 1527 501 999

Email: info@sti-emea.com Web: www.sti-emea.com



13

DoP-2531-CPR-232.1737-Rev0719



EN54-11

Type A Indoor Manual Call Point
Red Series 01 only

Specifications

Current Rating (All Series)	3 Amps 12 - 24V DC
Current Rating (Series 02 & 11)	3 Amps 125 - 250V AC
Housing and Mounting Box Material	Polycarbonate
Electrical Contact Material	Silver plated brass
Operating Temperature	-10°C to +55°C
Installation Terminal Conductor Size	0.5mm to 2.5mm
Humidity (no condensation) <small>Specifications are typical and given at 25°C</small>	0 to 95% Relative humidity